

XT Stair Edgings

Additional Profiles and Finishes

GRADUS

The Ultimate Stair Edging Solution...



Contents

4. XT Stair Edgings

Overview
NBS Source

5. Developed in line with the latest guidance...

BRE - Research and Guidelines
BS 8300-2:2018
The Building Regulations 2010 - Approved Document M (ADM)

6. XT Bronze

Channel finishes
Insert options
Bronze Stair Edgings

10. XT Aluminium

Channel finishes
Insert options
Aluminium Stair Edgings

16. Associated Products for Stairs & Floors

Welded Corners with TC1 Clips
Welded Corners with Fixed Flange
Welded Corners with TC3 Clips
Nap Trims

16. Gradus Grip GG290 - Stair Edging Adhesive

17. FREE Measuring Service

17. Fabrication Service

17. Light Reflectance Values (LRVs) and NCS References

18. A Fusion of Products

Gerflor and Gradus offer products which are ideal for use in a wide variety of applications including hospitality & leisure, residential developments, retail and commercial office.

XT™ Stair Edgings

XT is the ultimate stair edging solution, combining maximum safety, performance and aesthetics to reduce the risk of slips, trips and falls on stairs. **There is no equal.**

The introduction of our new XT Bronze profiles, new metal inserts, in addition to an enhanced range of finishes available across existing XT Aluminium profiles, offers an ideal solution for luxury hospitality & high-end residential applications.



Product specification data, product literature and BIM objects for our full XT range are available on NBS Source.

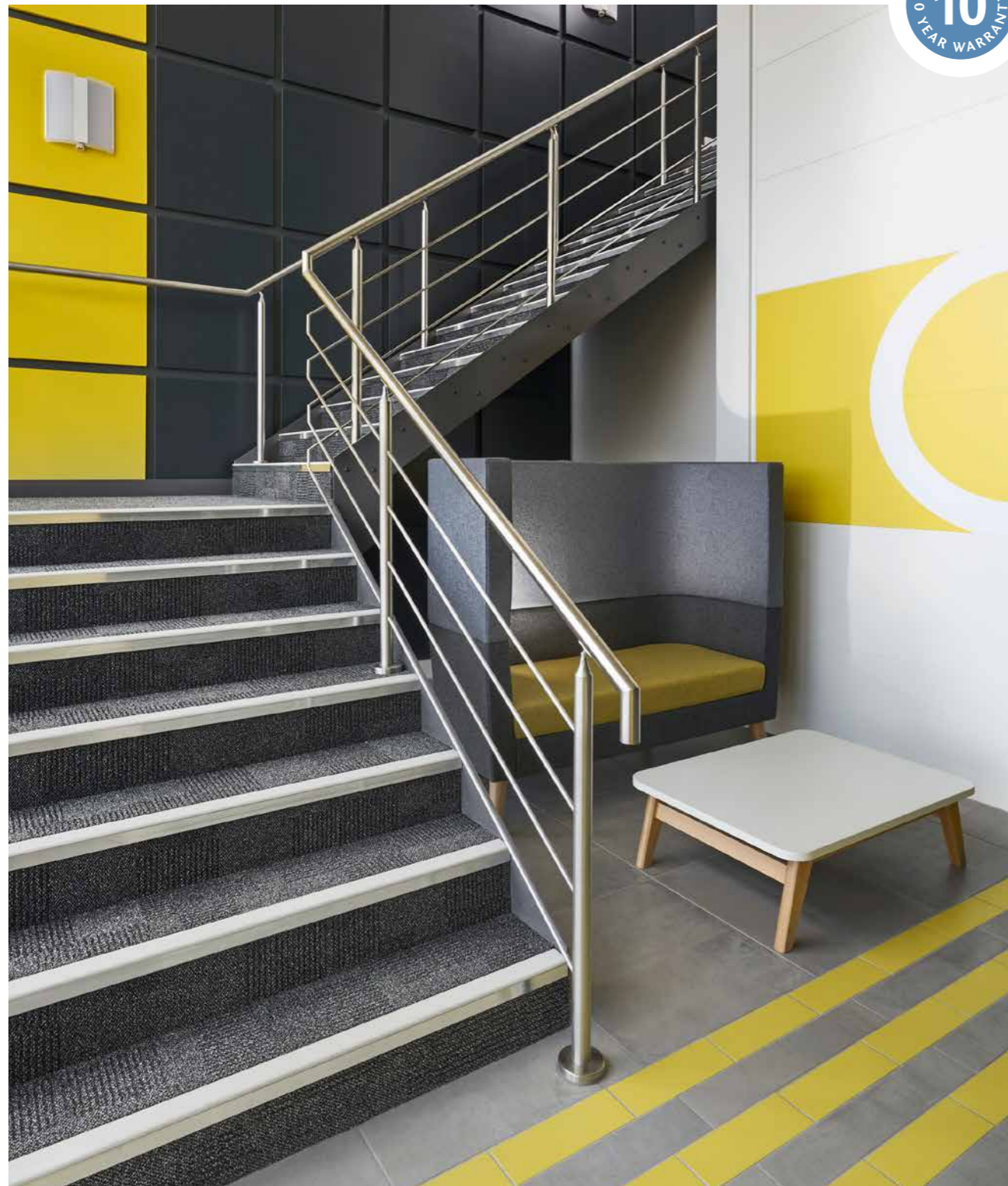

Developed in line with the latest guidance...

Supported by recommendations from BRE and the guidance contained within BS 8300-2:2018 and Approved Document M (ADM) of the Building Regulations 2010, building owners and specifiers can choose Gradus XT safe in the knowledge that it offers the ultimate solution in product design and performance to protect all groups of building users.

The Gradus XT range features a unique insert design that extends around the entire leading edge of the stair edging to ensure that foot contact is always made with the slip-resistant element of the stair edging. This is in line with the recommendations published within BRE (IP 15/03) information paper, which provides guidance to designers and building managers selecting stair edgings for non-domestic stairs.



Ideal for use with Gradus Grip (GG290) ultra strong stair edging adhesive, see page 16

Extended insert design around the entire leading edge of the stair edging

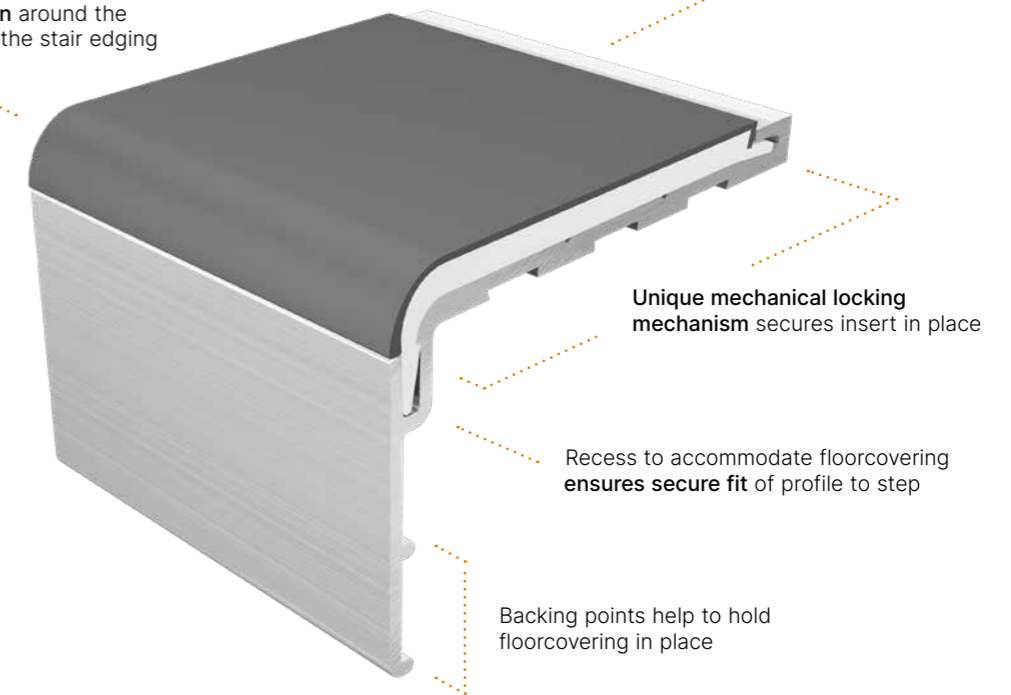

Guidance within BS 8300-2:2018 also states that 'The whole tread or the nosing should incorporate slip-resistant material, starting as close as practicable to the front edge of the nosing and extending the full width of the tread' (see diagram opposite).

Slip-resistance is further enhanced by a comprehensive choice of inserts and colours across our XT range, with options available to suit both dry and wet interior conditions. All our inserts are fully tested and achieve a **Pendulum Test Value of greater than 36**, which satisfies the requirements of BS 8300-2:2018.

The wide choice of insert colours & finishes **enable designers to achieve suitable colour contrast** with the surrounding floorcoverings in line with the guidance in ADM and BS 8300-2:2018. All Gradus products have been measured for Light Reflectance Values to ensure that sufficient contrast is achieved.



XT™ Bronze

NEW RANGE

XT Bronze stair edgings offer premium finishes for commercial applications including hospitality, leisure, retail, commercial office and premium residential.

Suitable for interior heavy traffic applications.

Used in conjunction with floorcoverings from all major manufacturers.

Information

- > For Light Reflectance Values (LRVs) and NCS references see page 17
- > XT profiles - UK patent GB2433437B. UK/EU Registered Design no 9/000465950 and 9/002471599.

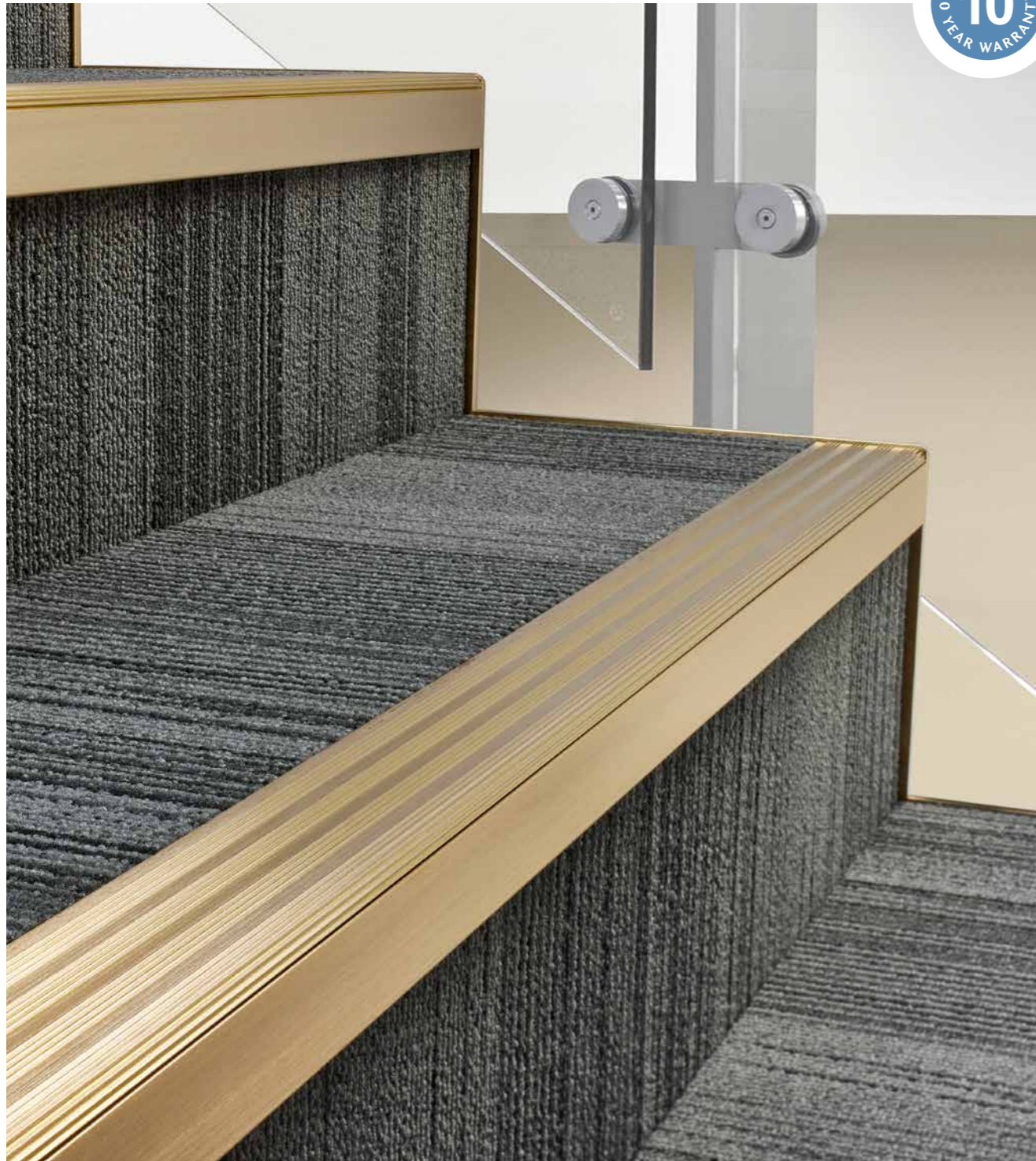

Channel and insert options



2 Channel finishes

NEW

Bronze channel finishes

Our Polished Bronze finish creates a sleek appearance, whilst Satin Bronze offers a matt finish that features a subtle brushed effect.

Polished Bronze

Satin Bronze



3 Insert options



Interior

Conditions: Interior Dry
Material: Pvc with mineral inclusion

Areas where there is no risk that the stairs will be contaminated by moisture.



Xtra-grip

Conditions: Interior Dry / Interior Wet
Material: Pvc with mineral aggregate

Increased surface roughness where the stair edging may become wet e.g. stairs close to entrances.



NEW

Metal Castellated

Conditions: Interior Dry / Interior Wet
Material: Bronze or aluminium

Provides an all-metal solution that features a castellated design.

Jet	Ink
Evergreen	Teal
Burgundy	Ocean
Spice	Coffee
Lead	Bronze
Steel	Linen
Glacier	Canvas
Wisp	Clay
Sky	Buttercup
Jade	Snowdrift

Onyx	Neptune
Forest	Aegean
Claret	Baltic
Chestnut	Umber
Graphite	Sepia
Quarry	Tuscan
Concrete	Pumice
Surf	Ochre
Bamboo	Frost
Ivory	Platinum

Bronze:



Aluminium:

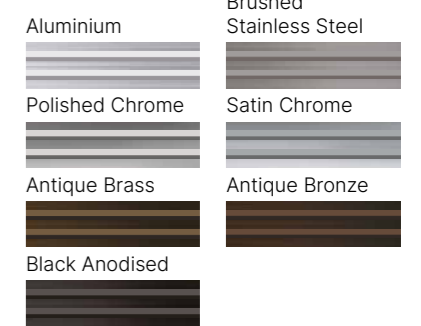

XT™ Bronze

NEW RANGE

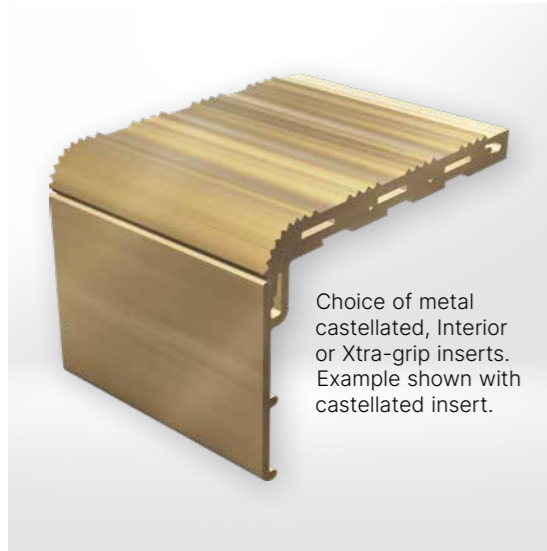

Channel & Insert options

- > All XT Bronze profiles available with a choice of metal castellated, Interior or Xtra-grip insert

Gauge options

- > Ramp - typically used with LVT, resilient flooring or where no surface floorcoverings are used
- > 2mm - typically used with LVT or resilient flooring
- > 5mm - typically used with carpet, LVT or resilient flooring with bevelled underlay

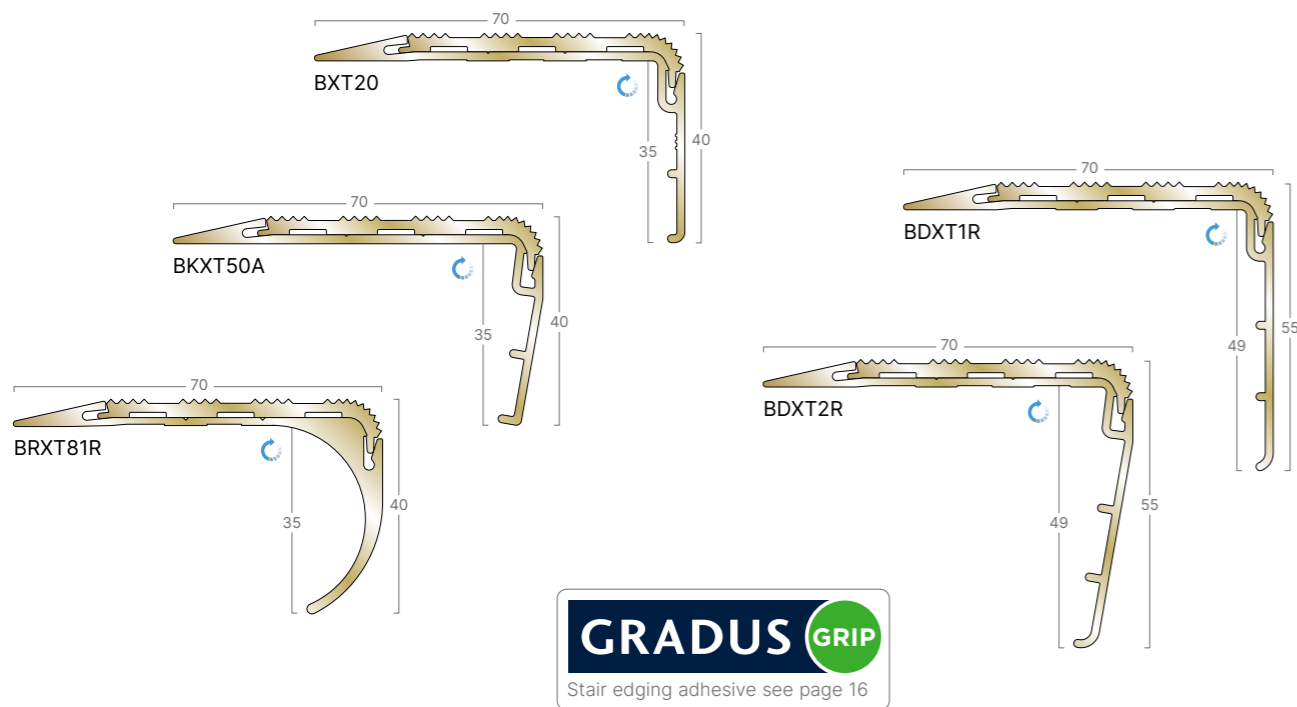

Channel options:

Metal finishes:

- Polished Bronze
- Satin Bronze

Insert options:

Metal Castellated:

- Polished Bronze
- Satin Bronze
- Aluminium
- Brushed Stainless Steel
- Polished Chrome
- Satin Chrome
- Antique Brass
- Antique Bronze
- Black Anodised

Interior:

- Jet
- Ink
- Ocean
- Teal
- Evergreen
- Lead
- Steel
- Glacier
- Wisp
- Sky
- Clay
- Jade
- Burgundy
- Spice
- Coffee
- Bronze
- Linen
- Canvas
- Buttercup
- Snowdrift

Xtra-grip:

- Onyx
- Neptune
- Baltic
- Aegean
- Forest
- Graphite
- Quarry
- Concrete
- Surf
- Bamboo
- Claret
- Chestnut
- Umber
- Sepia
- Tuscan
- Pumice
- Ochre
- Frost
- Ivory
- Platinum

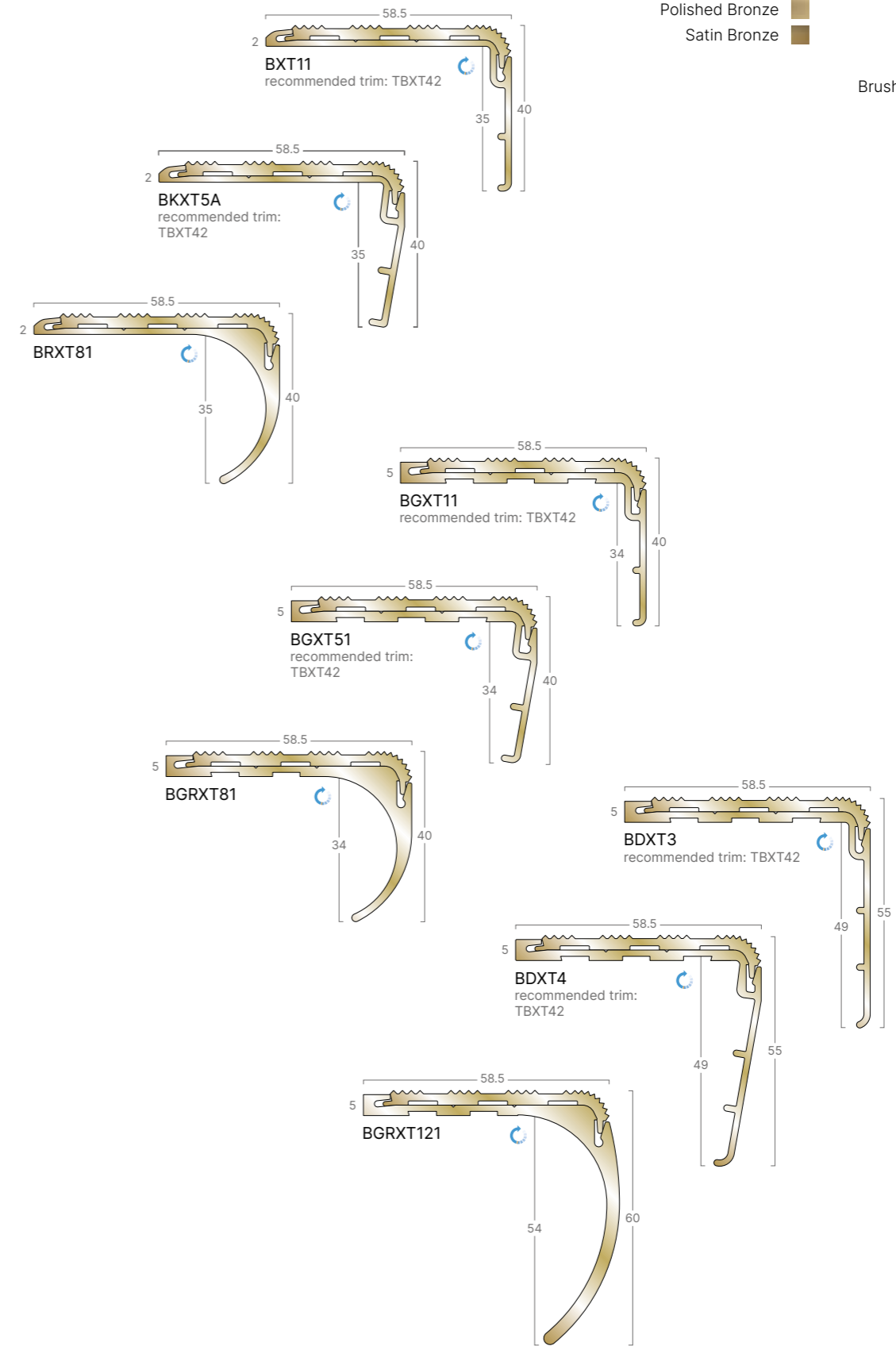

XT™ Aluminium

XT Aluminium stair edgings offer an ideal solution for commercial applications including offices, education and healthcare. Suitable for use in heavy traffic interior applications.

XT Aluminium is also offered in a choice of premium finishes for use in hospitality, leisure, retail, commercial office, premium residential and other prestigious medium traffic interior applications.

Used in conjunction with floorcoverings from all major manufacturers.

Information

- > For Light Reflectance Values (LRVs) and NCS references see page 17
- > XT profiles - UK patent GB2433437B. UK/EU Registered Design no 9/000465950, 9/002471599 and 9/001102875

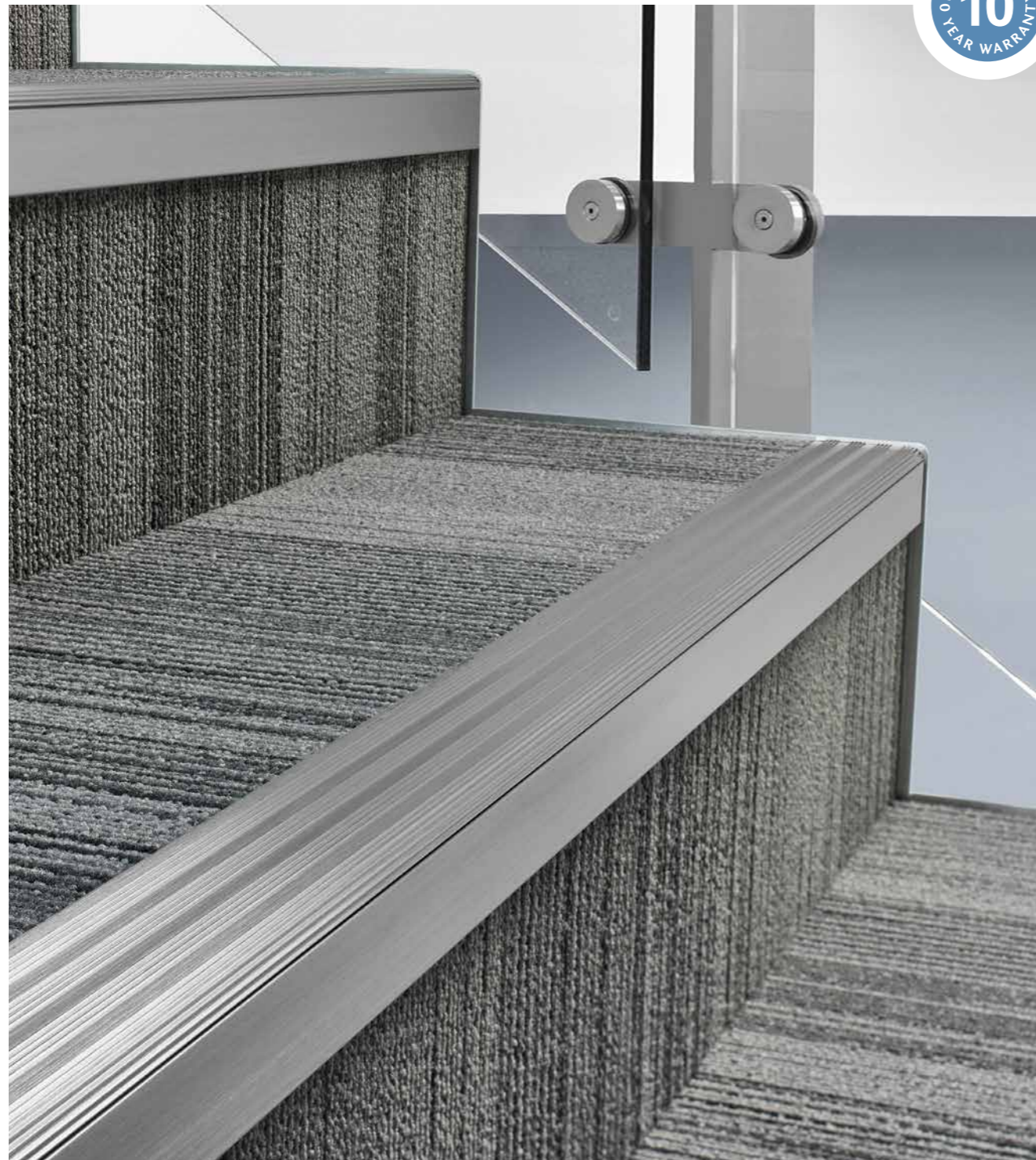

Channel and insert options

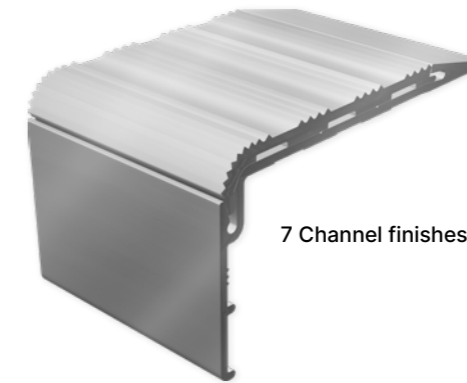

7 Channel finishes

3 Insert options

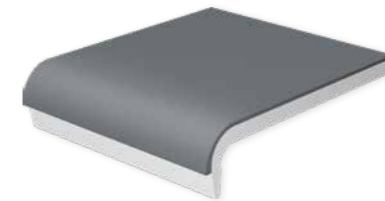

Interior

Conditions: Interior Dry
Material: Pvc with mineral inclusion

Areas where there is no risk that the stairs will be contaminated by moisture.

Jet	Ink
Evergreen	Teal
Burgundy	Ocean
Spice	Coffee
Lead	Bronze
Steel	Linen
Glacier	Canvas
Wisp	Clay
Sky	Buttercup
Jade	Snowdrift



Xtra-grip

Conditions: Interior Dry / Interior Wet
Material: Pvc with mineral aggregate

Increased surface roughness where the stair edging may become wet e.g. stairs close to entrances.

Onyx	Neptune
Forest	Aegean
Claret	Baltic
Chestnut	Umber
Graphite	Sepia
Quarry	Tuscan
Concrete	Pumice
Surf	Ochre
Bamboo	Frost
Ivory	Platinum

NEW

Aluminium channel finishes

XT Aluminium is now offered with an enhanced choice of attractive contemporary finishes, including our new Antique Brass and Antique Bronze effects.

Aluminium	Brushed Stainless Steel
Polished Chrome	Satin Chrome
Antique Brass	Antique Bronze
Black Anodised	

NEW

Metal Castellated

Conditions: Interior Dry / Interior Wet
Material: Aluminium or bronze

Provides an all-metal solution that features a castellated design.

Aluminium:	
Aluminium	Brushed Stainless Steel
Polished Chrome	Satin Chrome
Antique Brass	Antique Bronze
Black Anodised	
Bronze:	
Polished Bronze	Satin Bronze

XT™ Aluminium

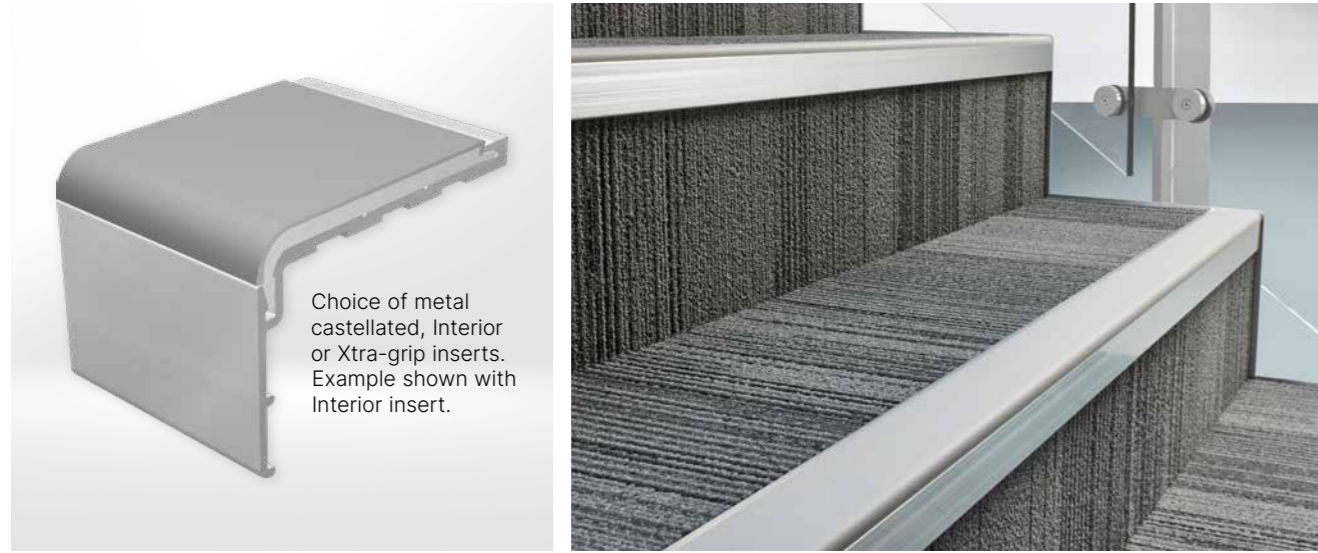

Choice of metal castellated, Interior or Xtra-grip inserts. Example shown with Interior insert.

Channel & Insert options

- > All XT Aluminium profiles available with a choice of metal castellated, Interior or Xtra-grip insert

Gauge options

- > Ramp - typically used with LVT, resilient flooring or where no surface floorcoverings are used
- > Notched Ramp - Designed to overlay 2mm vinyl or LVT
- > 2mm - typically used with LVT or resilient flooring

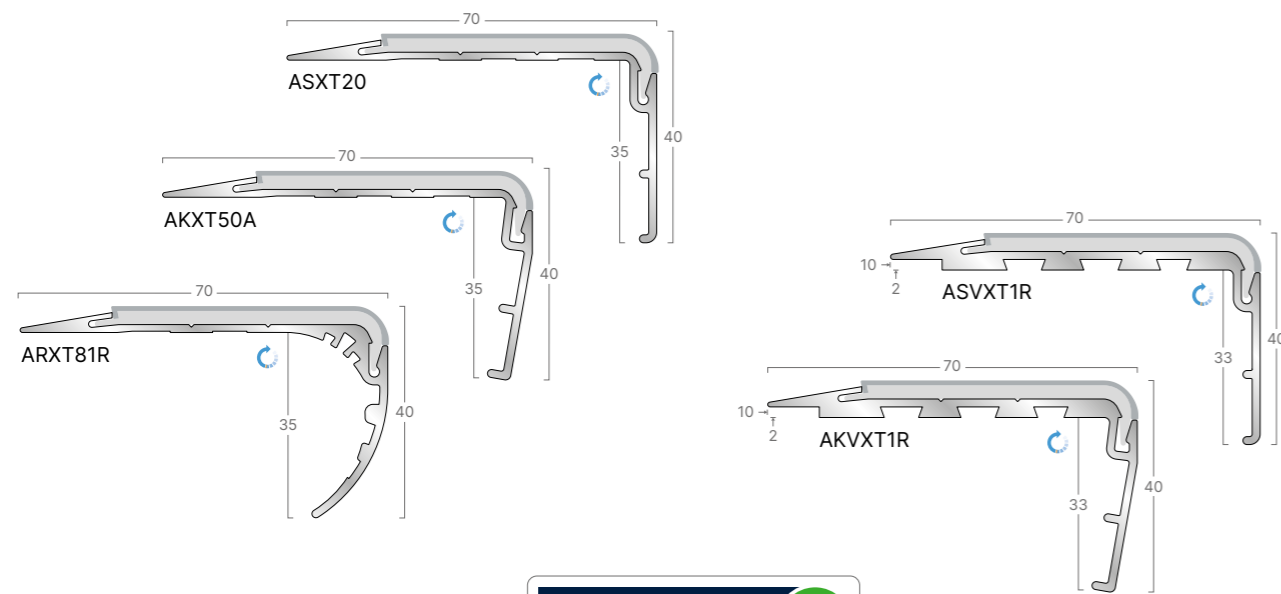

Channel options:

Metal finishes:

- Aluminium
- Brushed Stainless Steel
- Polished Chrome
- Satin Chrome
- Antique Brass
- Antique Bronze
- Black Anodised

Insert options:

Metal Castellated:

- Aluminium
- Brushed Stainless Steel
- Polished Chrome
- Satin Chrome
- Antique Brass
- Antique Bronze
- Black Anodised
- Polished Bronze
- Satin Bronze

Interior:

- Jet
- Ink
- Ocean
- Teal
- Evergreen
- Lead
- Steel
- Glacier
- Wisp
- Sky
- Clay
- Jade
- Burgundy
- Spice
- Coffee
- Bronze
- Linen
- Canvas
- Buttercup
- Snowdrift

Xtra-grip:

- Onyx
- Neptune
- Baltic
- Aegean
- Forest
- Graphite
- Quarry
- Concrete
- Surf
- Bamboo
- Claret
- Chestnut
- Umber
- Sepia
- Tuscan
- Pumice
- Ochre
- Frost
- Ivory
- Platinum

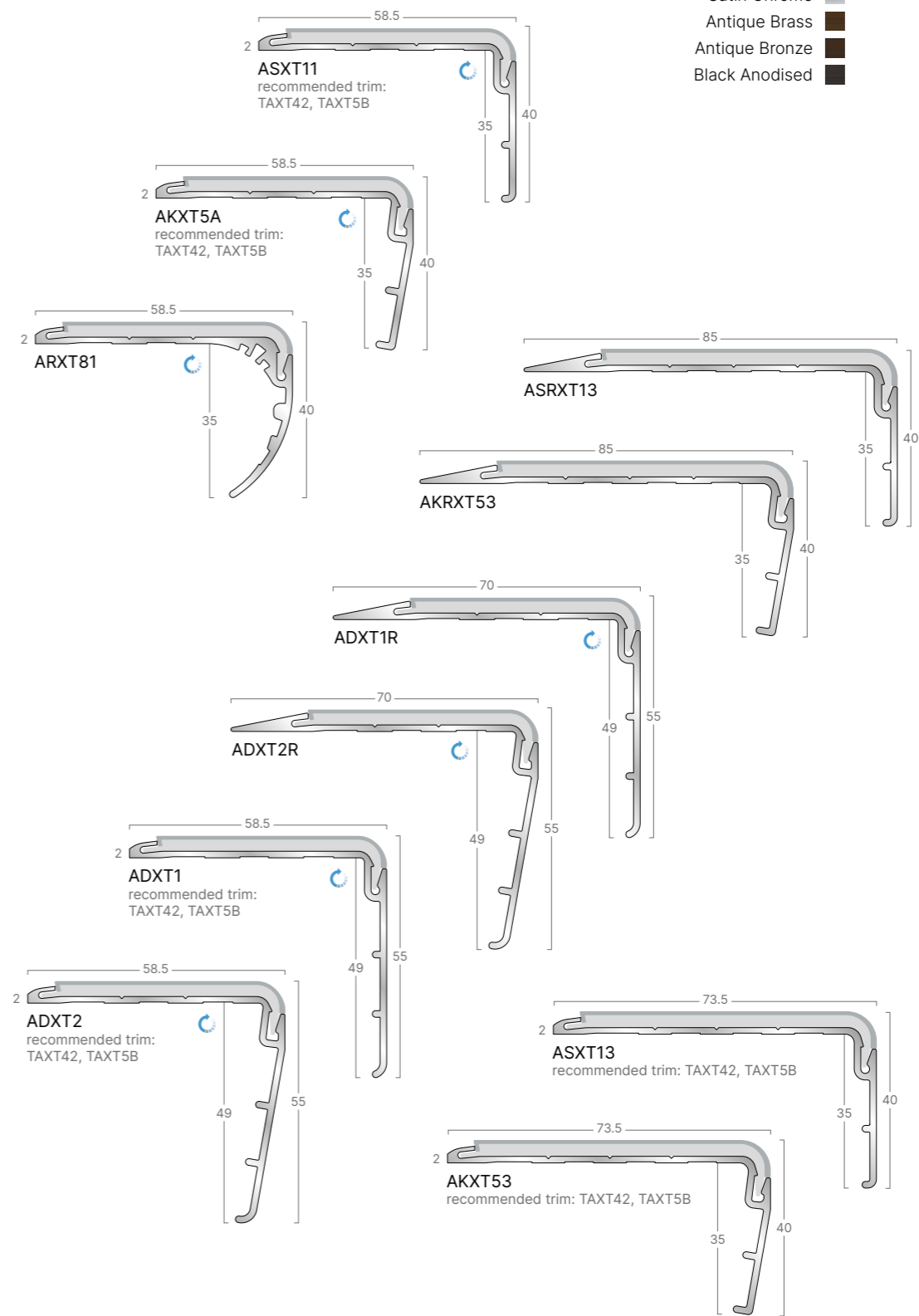

XT™ Aluminium

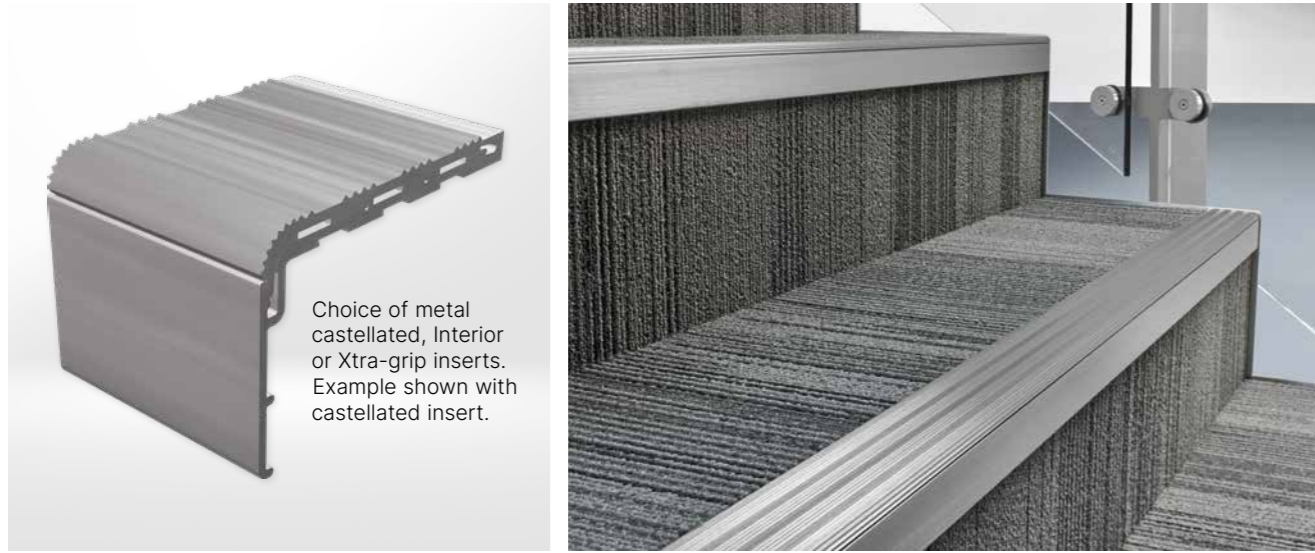

Channel & Insert options

- > All XT Aluminium profiles available with a choice of metal castellated, Interior or Xtra-grip insert.

Gauge options

- > 5mm - typically used with LVT, carpet or resilient flooring with bevelled underlay
- > 10mm - 15mm - typically used with ceramics, stone and marble

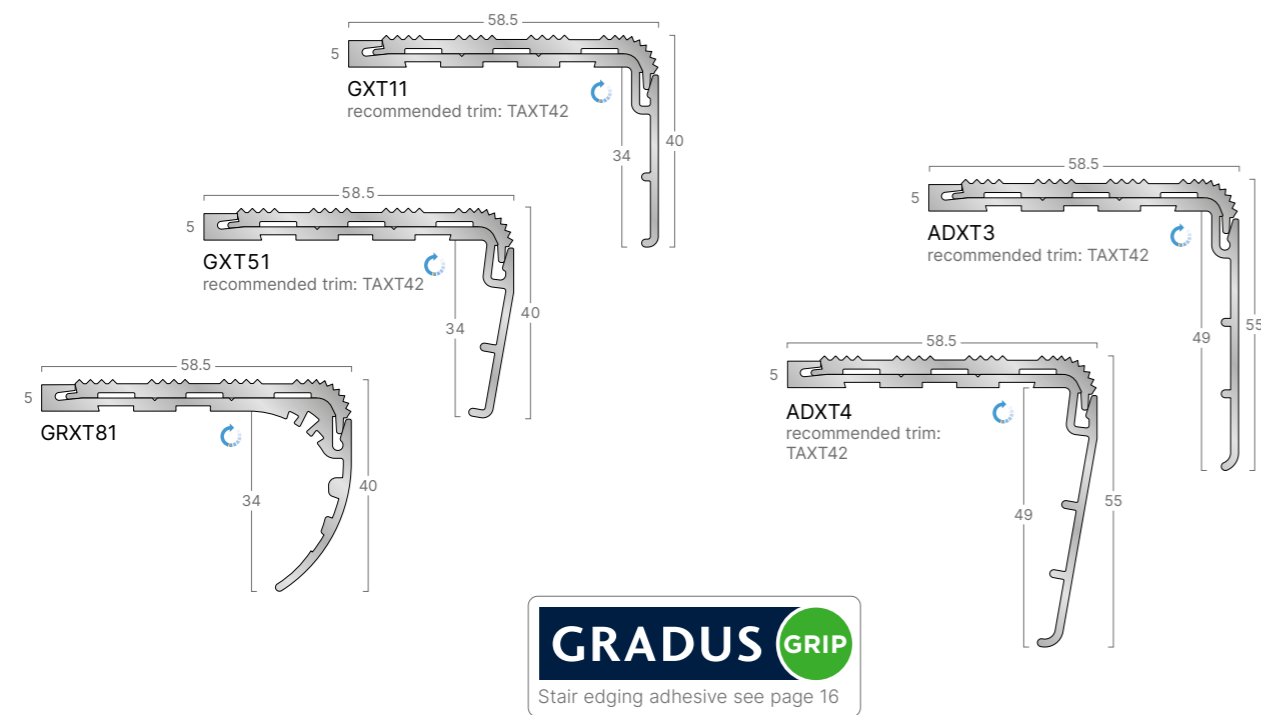

Channel options:

Metal finishes:

- Aluminium
- Brushed Stainless Steel
- Polished Chrome
- Satin Chrome
- Antique Brass
- Antique Bronze
- Black Anodised

Insert options:

Metal Castellated:

- Aluminium
- Brushed Stainless Steel
- Polished Chrome
- Satin Chrome
- Antique Brass
- Antique Bronze
- Black Anodised
- Polished Bronze
- Satin Bronze

Interior:

- Jet
- Ink
- Ocean
- Teal
- Evergreen
- Lead
- Steel
- Glacier
- Wisp
- Sky
- Clay
- Jade
- Burgundy
- Spice
- Coffee
- Bronze
- Linen
- Canvas
- Buttercup
- Snowdrift

Xtra-grip:

- Onyx
- Neptune
- Baltic
- Aegean
- Forest
- Graphite
- Quarry
- Concrete
- Surf
- Bamboo
- Claret
- Chestnut
- Umber
- Sepia
- Tuscan
- Pumice
- Ochre
- Frost
- Ivory
- Platinum

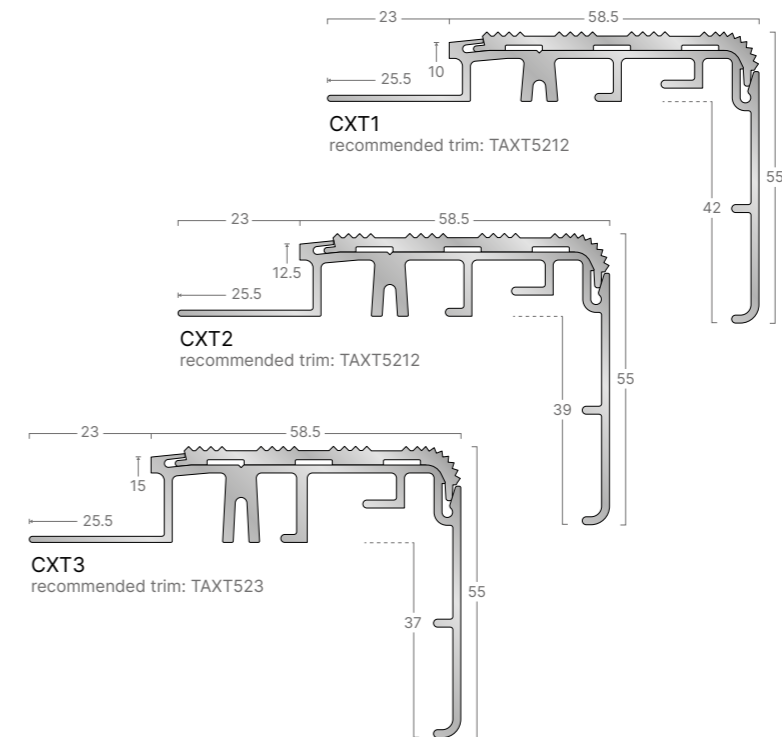
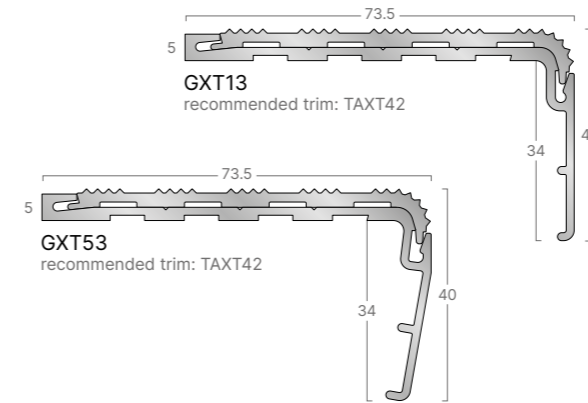

Associated Products for Stairs & Floors

Welded Corners with TC1 Clips

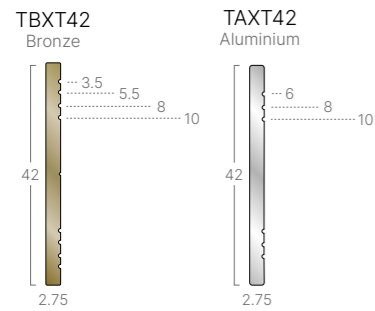

Welded Corner with Fixed Flange

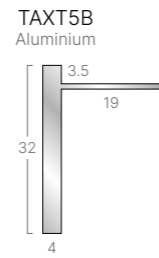

Bronze trim finishes:

- Satin Bronze
- Polished Bronze

Aluminium trim finishes:

- Aluminium
- Brushed Stainless Steel
- Polished Chrome
- Satin Chrome
- Antique Brass
- Antique Bronze
- Black Anodised

Welded Corners with TC3 Clips

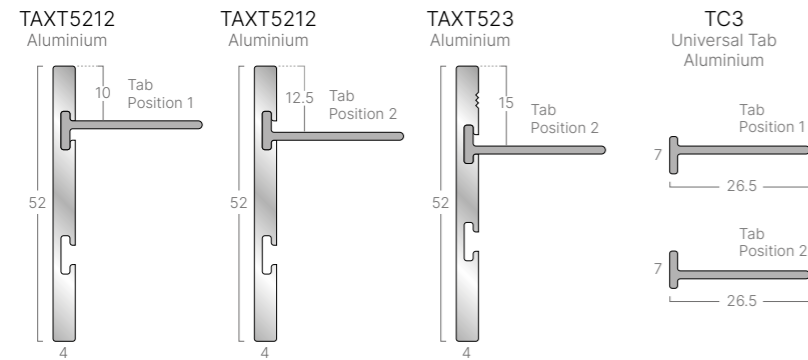

Nap Trims

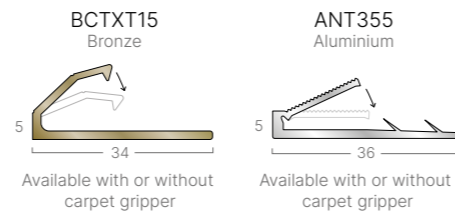

Gradus Grip GG290 - Stair Edging Adhesive

A secure bond between the stair edging and the step is essential to ensuring a safe installation.

Gradus Grip is a solvent free rapid curing flexible adhesive with excellent gap filling properties that is suitable for bonding stair edgings to most solid surfaces.

Why choose Gradus Grip:

- > **Saves time & money** - quick and easy installation
- > **10 year warranty** - on both the Gradus stair edging and Gradus Grip
- > **No more screw head cover plugs** - improved aesthetic and easier to maintain
- > **Ultra strong bond** - complete peace of mind

The stair edging, insert format, type and condition of the substrate and the application will affect the installation method required. Installation instructions are available to download at www.gradus.com.



FREE Measuring Service

Eliminate risk by arranging for a **FREE*** and accurate stair edging measure with Gradus

- > Save time
- > Save money
- > Reduces Waste
- > Avoids Errors

For further details or to **book a measure**, call Gradus Technical Support on 01625 428922.

*UK mainland only.

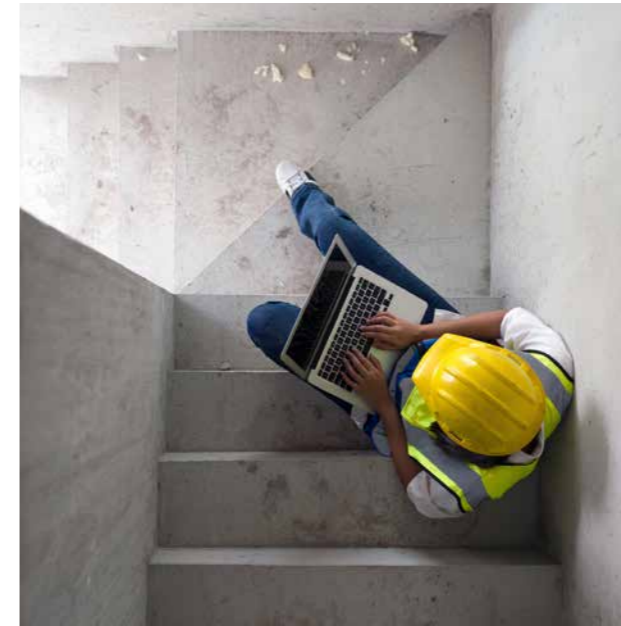

Fabrication Service

Curved Stair Edgings

- > Fastest, most reliable fabrication service in the UK
- > Ready for despatch within 5 working days*

Welded Corners

- > 83° and 90° welded corners are available in matching finishes

*Terms & Conditions apply - see www.gradus.com

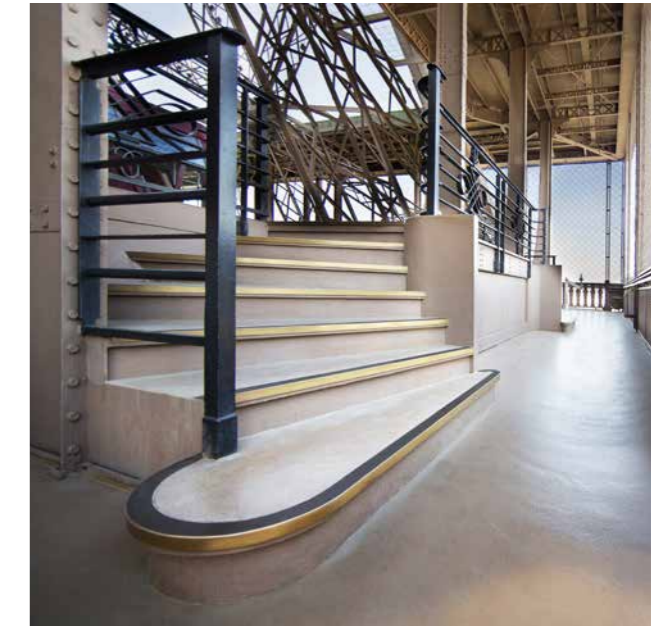

Light Reflectance Values (LRVs) and NCS References

Metal Castellated			Xtra-grip			Interior Standard Finish		
Colour Reference	LRV	NCS	Colour Reference	LRV	NCS	Colour Reference	LRV	NCS
Aluminium	74.21	4005-B80G	Onyx	4.52	8502-B	Jet	4.56	8502-B
Brushed Stainless Steel	48.85	6020-G70Y	Neptune	5.03	8010-R70B	Ink	4.96	8010-R70B
Satin Chrome	50.73	S7502-G	Baltic	8.27	6020-R90B	Ocean	8.00	6020-R90B
Polished Chrome	58.17	S9000-N	Aegean	6.29	6530-B30G	Teal	6.20	6530-B30G
Black Anodised	4.35	8500N	Forest	6.13	7020-B70G	Evergreen	6.69	7020-B70G
Antique Brass	9.78	7005-Y20R	Graphite	12.56	6502-B	Lead	12.77	7005-R50B
Antique Bronze	7.55	8005-R20B	Quarry	24.71	4500-N	Steel	26.99	4500-N
Polished Bronze	66.86	4050-G40Y	Concrete	37.44	2502-B	Glacier	42.09	2502-B
Satin Bronze	59.60	2040-R20B	Surf	43.58	1515-R90B	Wisp	58.17	2000-N
			Bamboo	45.84	2005-B80G	Sky	52.63	1515-R90B
			Claret	6.61	6030-R10B	Clay	47.97	2502-Y
			Chestnut	17.51	4050-Y70R	Jade	53.98	2005-G
			Umber	5.71	8005-Y50R	Burgundy	5.70	6030-R10B
			Sepia	28.59	5020-Y20R	Spice	15.37	4050-Y70R
			Tuscan	34.86	3010-Y40R	Coffee	6.05	8010-Y50R
			Pumice	46.83	2005-Y30R	Bronze	28.05	5020-Y20R
			Ochre	49.97	1060-Y	Linen	38.59	3010-Y30R
			Frost	66.51	1002-G50Y	Canvas	53.27	2005-Y30R
			Ivory	43.77	3000-N	Buttercup	55.54	1070-Y
			Platinum	52.79	2002-R50B	Snowdrift	83.77	0500-N

Project Rainbow and ADM recommend that there is at least a 30 point difference between the LRVs of the stair nosing and floorcovering to achieve a suitable contrast.

For further details contact Gradus Technical Support on 01625 428922.

A Fusion of Products

Gerflor and Gradus offer products which are ideal for use in a wide variety of applications including hospitality & leisure, residential developments, retail and commercial office.



LED Architectural Lighting



Luxury Vinyl Tiles & Planks (LVT)



Barrier Matting Systems

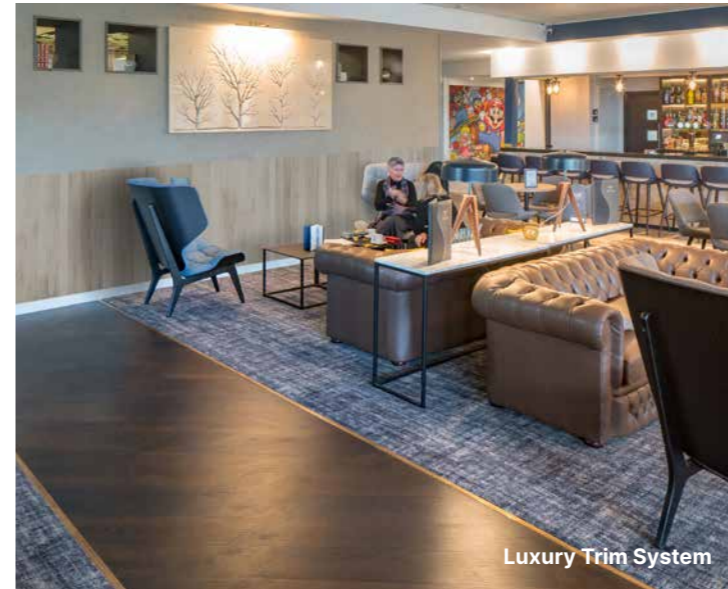

Luxury Trim System

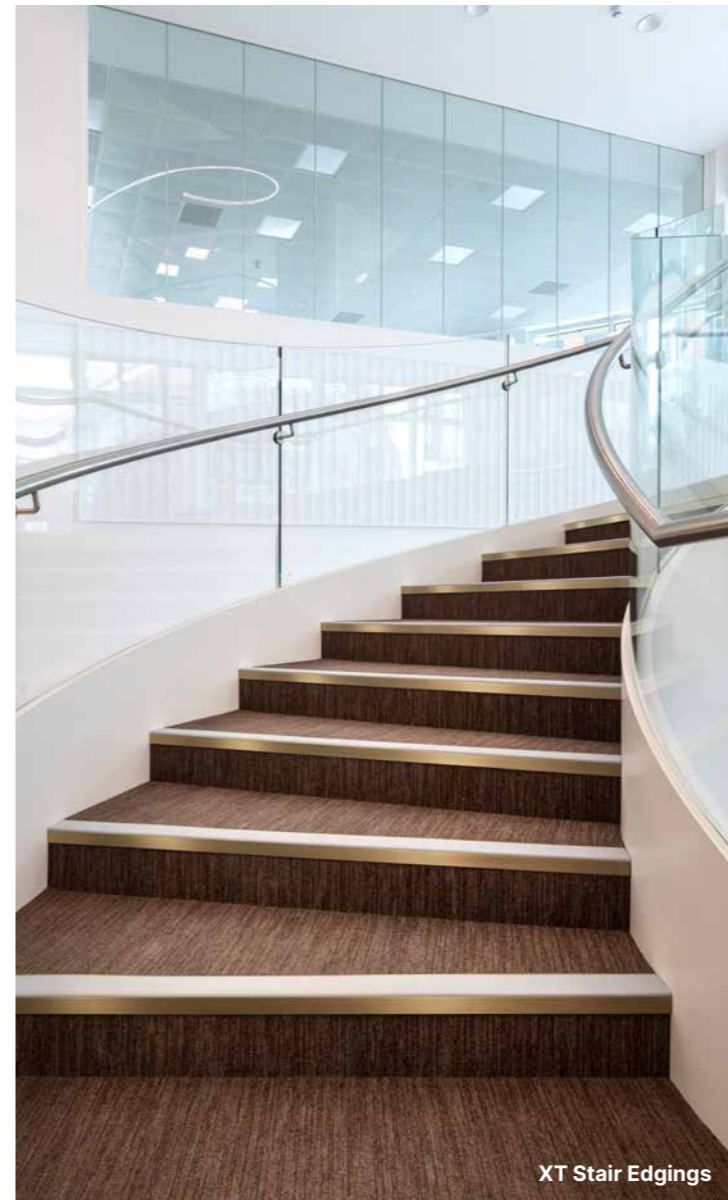

XT Stair Edgings



Premium Carpet Tile and Plank



GRADUS

Gradus Ltd Park Green Macclesfield Cheshire SK11 7LZ

For enquiries outside the UK and Eire contact Gradus International on +44 (0)1625 613780

Gradus International
England

Tel +44 (0) 1625 613780

Gradus Far East
Singapore

Tel: (+65) 6734 5933

call: 01625 428922

gradus.com